

Input Voltage	Light Source	Color Rendering Index	Color Temperature	Beam Angle	Application Temperature	Material	Cover Type
220-240V~ (50/60Hz)	SMD5730	>80	3000 6500K	180°	-20~45°C	PC Aluminum	PMMA acrylic

Model	KL-RCL/20500
Power	35W
Lumen	2625-2800lm
Dimension	Φ500mm*H70mm
Function1	Normal
Function2	TRIAC Dimmer
Function3	Remote Dimmer

Light Distribution Curve 6000K

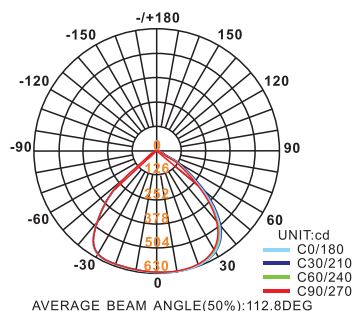

Average E(LX) Figure 6000K

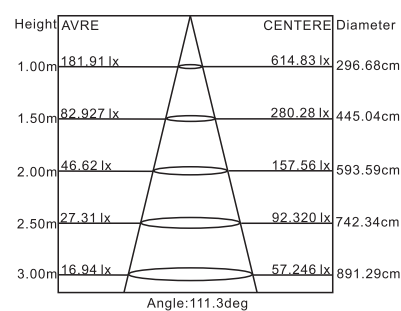

Model	KL-RCL/20600
Power	55W
Lumen	4125-4400lm
Dimension	Φ600mm*H70mm
Function1	Normal
Function2	TRIAC Dimmer
Function3	Remote Dimmer

Light Distribution Curve 6000K

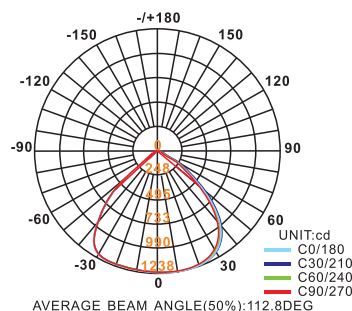

Average E(LX) Figure 6000K

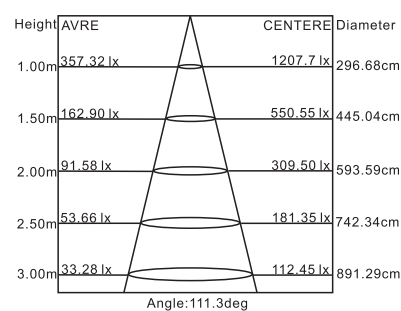

Installation and Operation Instruction:

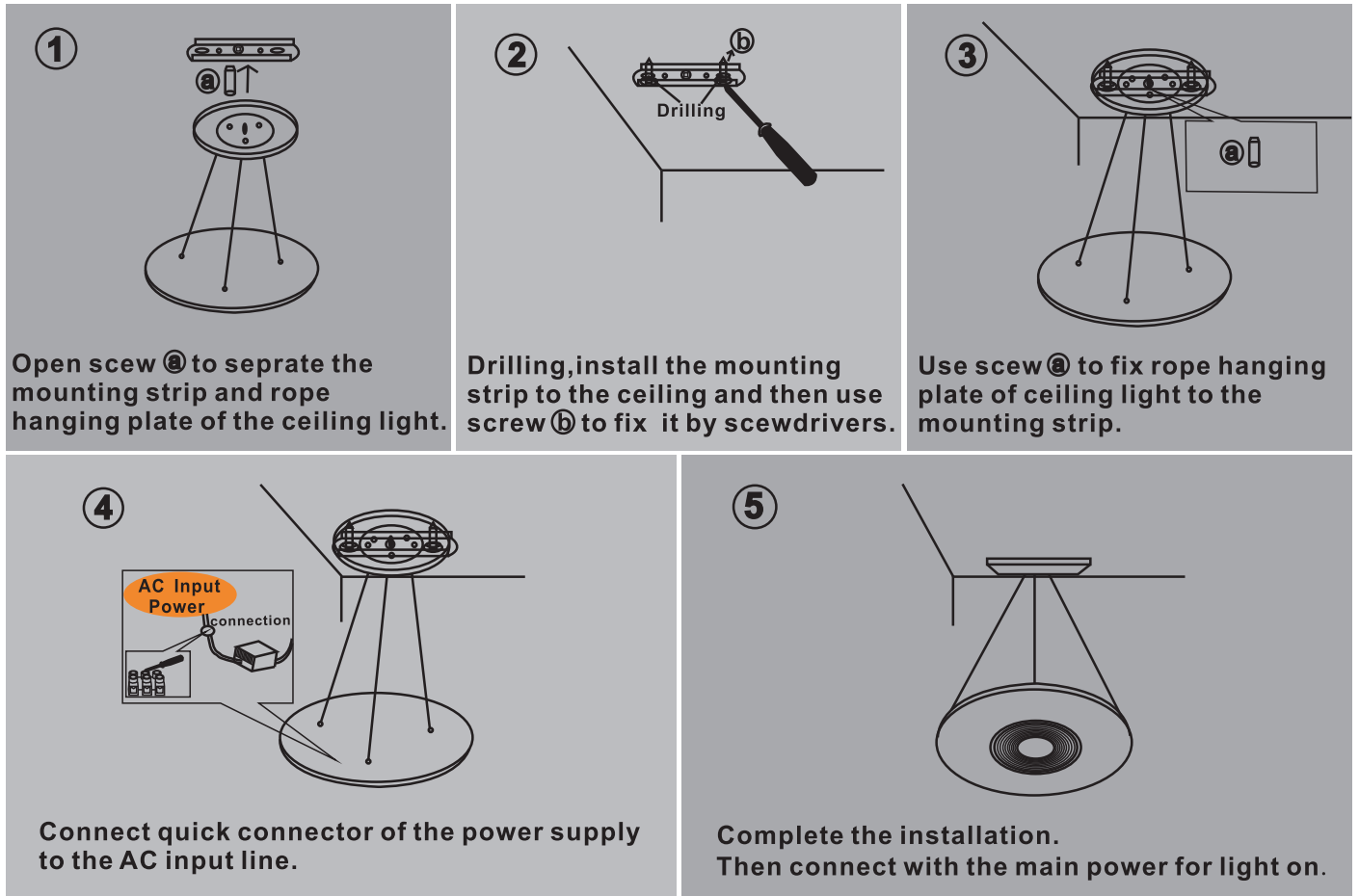

The Wiring Diagram:

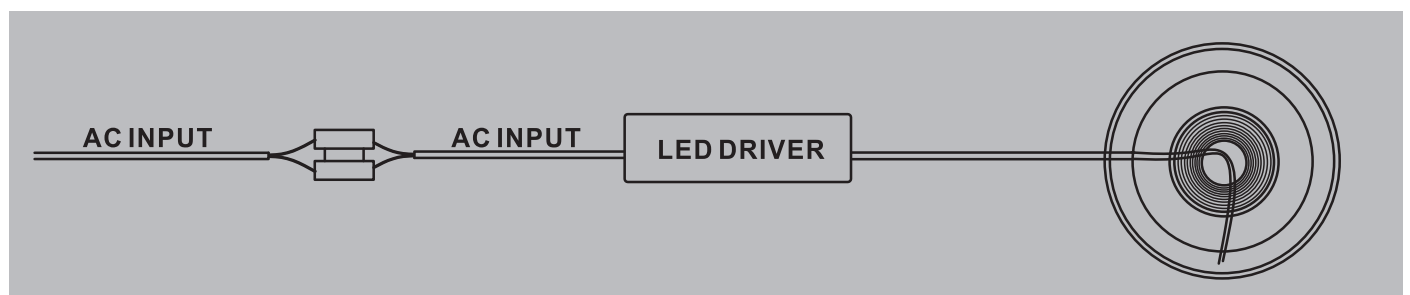

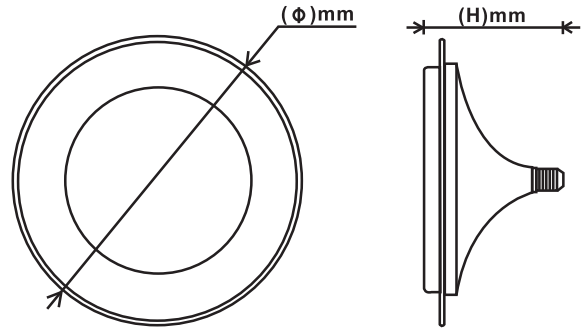

Input Voltage	Light Source	Color Rendering Index	Color Temperature	Beam Angle	Application Temperature	Material	Cover Type
220-240V~ (50/60Hz)	SMD5730	>80	3000 6500K	180°	-20~45°C	PC Aluminum	PMMA acrylic

Model	KL-RCL/21200
Power	18W
Lumen	2100-2240lm
Dimmension	Φ150mm*H90mm
Function1	Normal
Function2	TRIAC Dimmer
Function3	Remote Dimmer

Light Distribution Curve 6000K

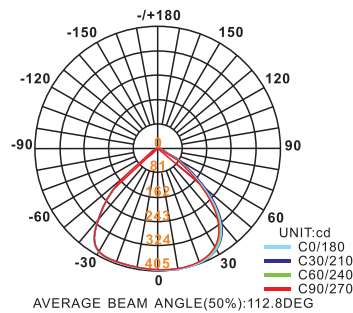

Average E(LX) Figure 6000K

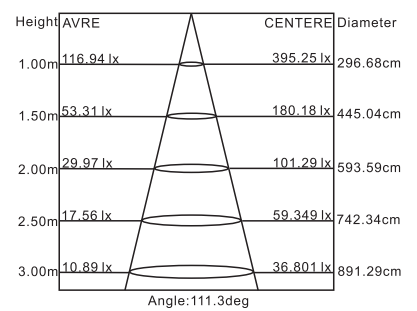

Model	KL-RCL/21250
Power	36W
Lumen	2700-2880lm
Dimmension	Φ200mm*H105mm
Function1	Normal
Function2	TRIAC Dimmer
Function3	Remote Dimmer

Light Distribution Curve 6000K

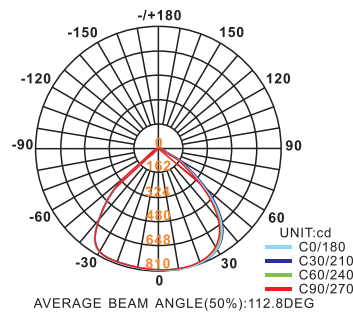

Average E(LX) Figure 6000K

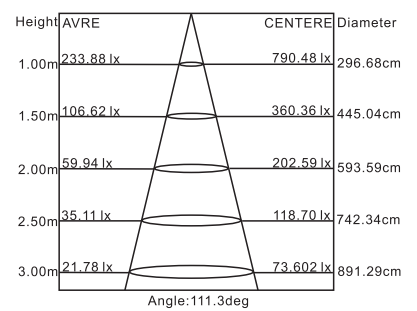

Model	KL-RCL/21300
Power	48W
Lumen	3600-3840lm
Dimmension	Φ250mm*H105mm
Function1	Normal
Function2	TRIAC Dimmer
Function3	Remote Dimmer

Light Distribution Curve 6000K

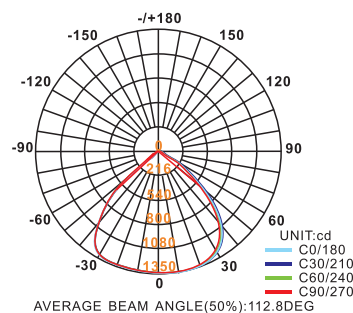

Average E(LX) Figure 6000K

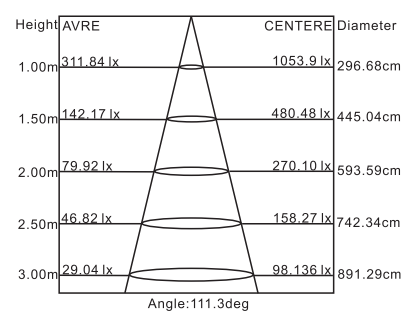

Installation and Operation Instruction:

Spiral Type

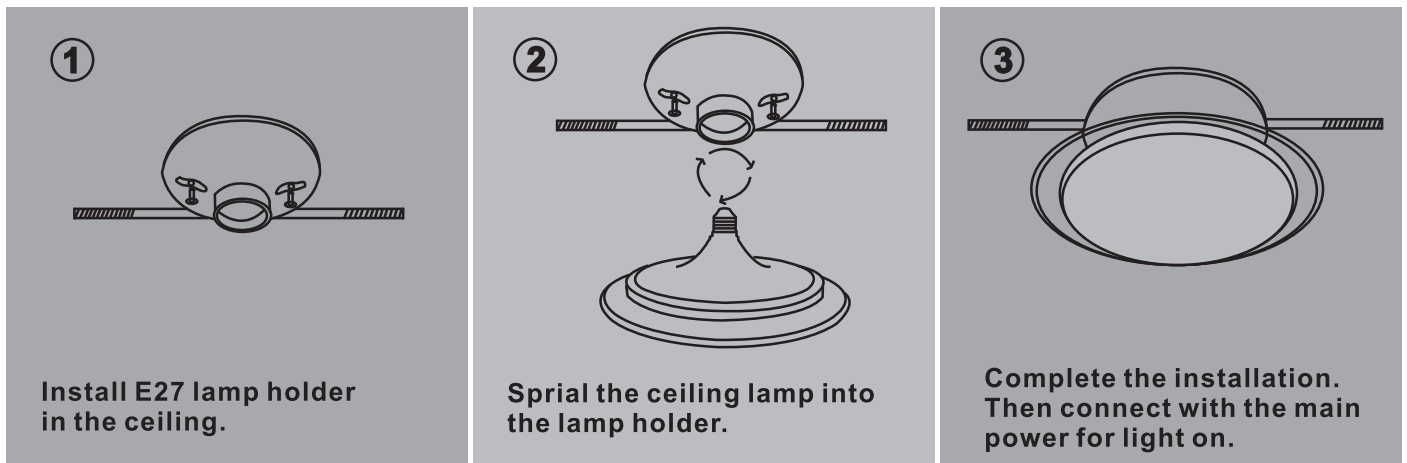

Hang Type

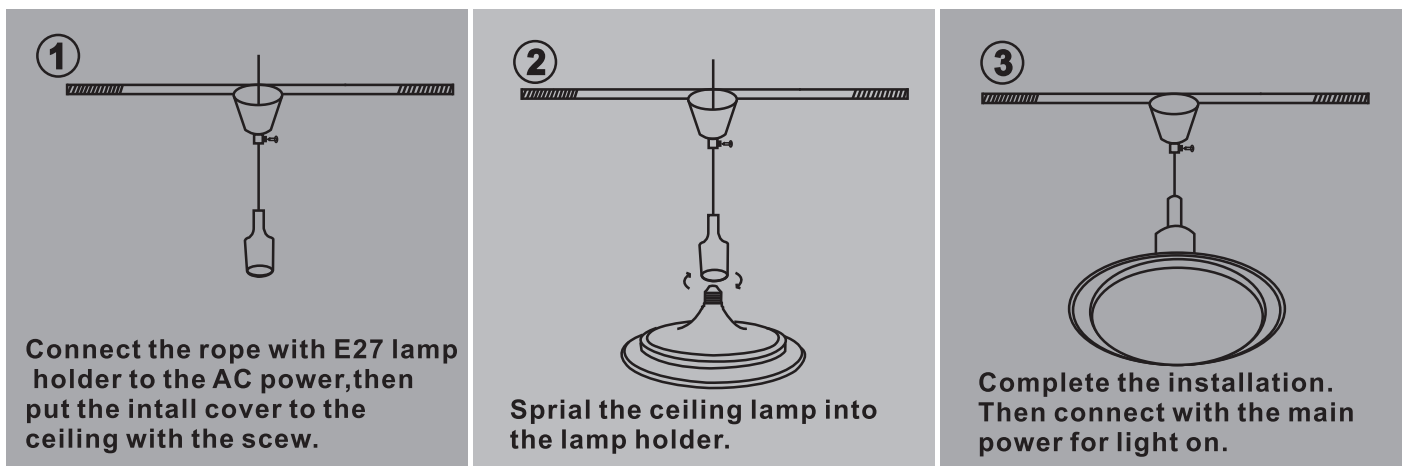

The Wiring Diagram:

